



*keeping your home  
safe and clean*

---

# USERS MANUAL

---

## Desiccant Dehumidifier Model: ECO DD322FW SIMPLE

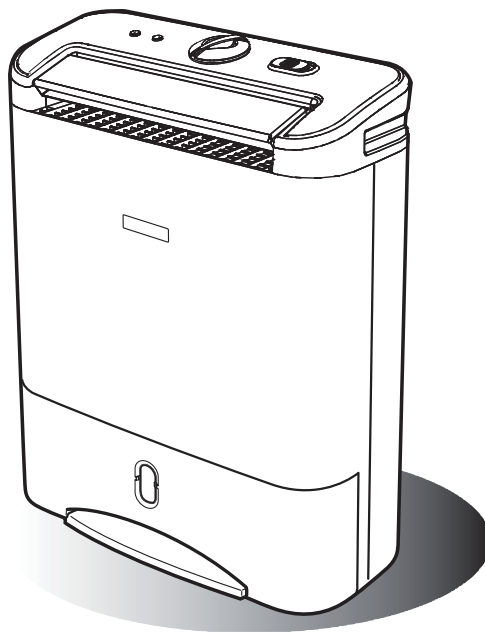

### **Read This Manual**

Inside you will find many helpful hints on how to use and maintain your dehumidifier properly. Just a little preventative care on your part can save you a great deal of time and money over the life of your dehumidifier. You'll find many answers to common problems in the chart of troubleshooting tips. Review the chart of Troubleshooting Tips before calling your service engineers.

<p><b>ECOAIR TECHNICAL SUPPORT</b> UK TEL: +44 208 459 2458 EMAIL: <a href="mailto:technical@ecoair.org">technical@ecoair.org</a></p>
---

IMPORTANT SAFETY INSTRUCTIONS .....	1
BS PLUG WIRING .....	2
FEATURES .....	3
PRODUCT DESCRIPTION .....	3
THE CONTROL PANEL .....	4
OPERATING INSTRUCTIONS .....	5
HOW TO USE YOUR DEHUMIDIFIER .....	6
UNIT SETUP .....	7
TO OPERATE SAFELY .....	7
TO EMPTY THE BUCKET .....	8
PERMENANT DRAIN OPTION .....	8
MAINTENANCE .....	9
TROUBLESHOOTING .....	10-11
SPECIFICATIONS .....	12
SERVICE AND WARRANTY .....	13

# IMPORTANT SAFETY INSTRUCTIONS

## PLEASE READ ALL INSTRUCTIONS CAREFULLY BEFORE OPERATING.

**WARNING** - This appliance is intended for use in a domestic environment only. Any other use is not recommended by the manufacturer and may cause fire, electrical shocks or other injury to person or property.

When using electrical appliances, basic safety precautions should always be followed:

1. Do not operate the unit with a damaged cord or plug, after it malfunctions or has been dropped or damaged in any way. Return to an authorized service facility for examination and repair.
2. This unit should always be kept in an upright position to avoid any damage. Locate the unit on a flat stable surface during operation.
3. Check the household voltage to ensure it matches the units rated specification before operating.
4. Operate this unit in an ambient temperature between 1°C and 35°C.
5. Ensure that the air inlets and outlets are not blocked or covered.
6. Do not place the unit too close to curtains or other objects - min 40cm.
7. When using the  "LAUNDRY" mode to speed up the drying of wet clothes in the room, please keep the clothing at a safe distance from the unit to prevent water from dripping onto the unit.
8. Never place anything on top of the unit and do not cover with any kind of material while in use.
9. This product is intended for domestic and light office use ONLY and not for commercial, industrial or outdoor use.
10. To protect against electrical shocks, do not immerse unit, plug or cord in water, or spray with liquids.
11. Never unplug the power cord without turning off first, as this could damage the unit.
12. Always unplug the unit when not in use or moving location. To disconnect from the power supply, grip the plug and pull from the power socket. Never pull by the cord.
13. Always empty the water tank before storing the unit away.
14. Close supervision is necessary when any appliance is used by or near children and pets.
15. Do not run power cord under carpeting, or cover with rugs or runners. Arrange the cord away from areas where it may be tripped over.
16. Never operate or store the unit in direct sunlight.
17. To repair the unit, take it to a qualified service engineer. Repairs carried out by unqualified people may cause damage to the unit or injury to persons or property and void the warranty.
18. Where possible, avoid the use of an extension cable as they may overheat and cause a risk of fire. Only use an extension cord after ensuring it is in perfect condition.
19. Do not use the unit without the air filter.
20. Do not leave the unit running unattended for long periods of time as a safety precaution.

This appliance is not intended for use by persons (including children) with reduced physical, sensory or mental capabilities, or lack of experience and knowledge, unless they have been given supervision or instruction concerning use of the appliance by a person responsible for their safety. Children should be supervised to ensure that they do not play with the appliance.

**SAVE AND READ THESE IMPORTANT SAFETY INSTRUCTIONS**

**Wiring Instructions:** Should it be necessary to change the plug please note the wires in the mains lead are coloured in accordance with the following code:

**BLUE - NEUTRAL**  
**BROWN - LIVE**  
**GREEN AND YELLOW - EARTH**

As the colours of the wires in the mains lead of this appliance may not correspond with the coloured markings identifying the terminals in your plug, proceed as follows:

1. The **BLUE** wire is the **NEUTRAL** and must be connected to the terminal which is marked with the letter **N** or coloured **BLACK**.
2. The **BROWN** wire is the **LIVE** and must be connected to the terminal which is marked with the letter **L** or coloured **RED**.
3. The **GREEN/YELLOW** is the **EARTH** and must be connected to the terminal which is marked with the letter **E** or  $\oplus$  or coloured **GREEN OR GREEN/YELLOW**.
4. Always ensure that the cord grip is positioned and fastened correctly.

If a **13A (BS 1363)** fused plug is used it must be fitted with a **13A** fuse. If in doubt consult a qualified electrician.

### Wiring for a 13 Amp Plug (BS1363)

Please note. The Earth Terminal is marked with the letter **E** or  $\oplus$  Earth Symbol.

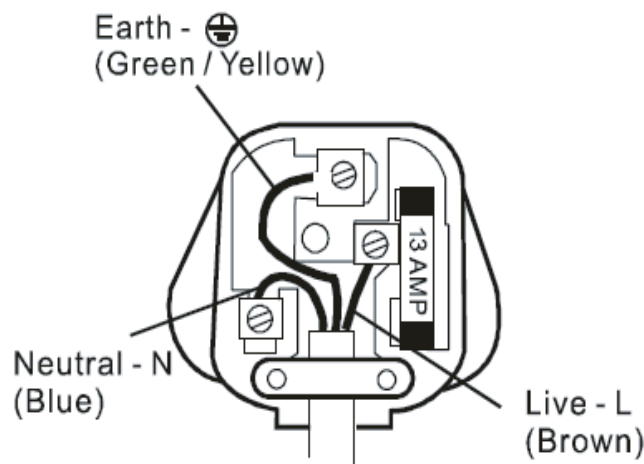

# FEATURES

- **Compressorless dehumidifier** - uses desiccant rotor technology
- **Environmentally friendly** with no harmful gases & quiet in operation
- **Moisture removal** - 10 litres/day (20°C RH60%)
- **Water tank capacity** - 3.5 litres
- **Laundry mode** - set on continuous running
- **Temperature range for use** ~ 1°C - 35°C
- **Light & portable** with carry handle
- **Removable water bucket with handle**
- **Operating light**
- **Quiet and Turbo operation**
  - 2 speed selection
- **Manual adjustable louvre**

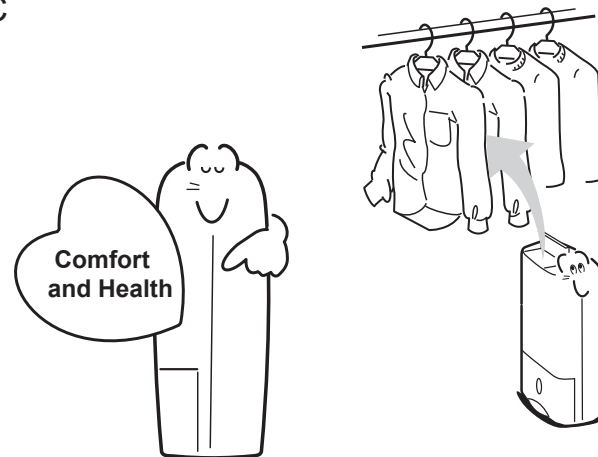
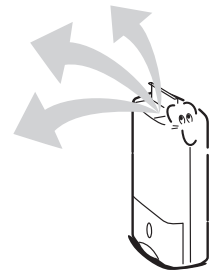

# PRODUCT DESCRIPTION

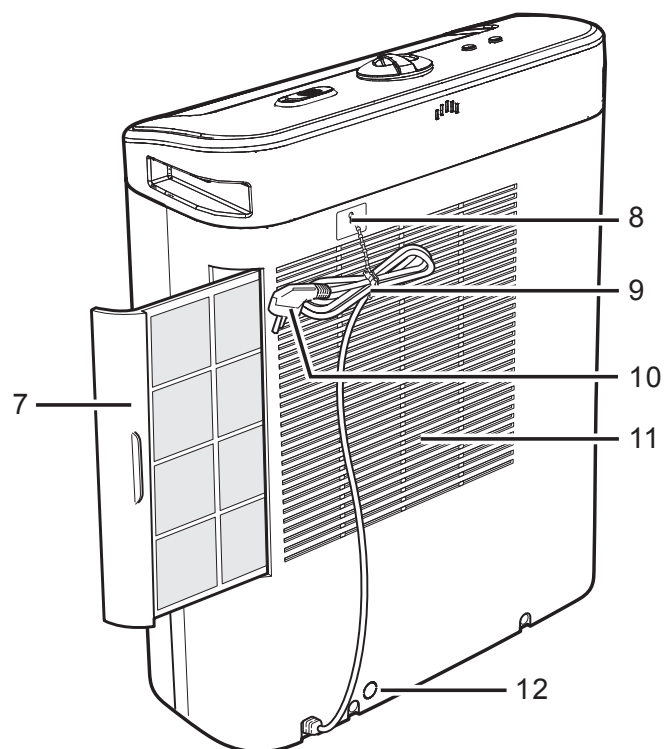
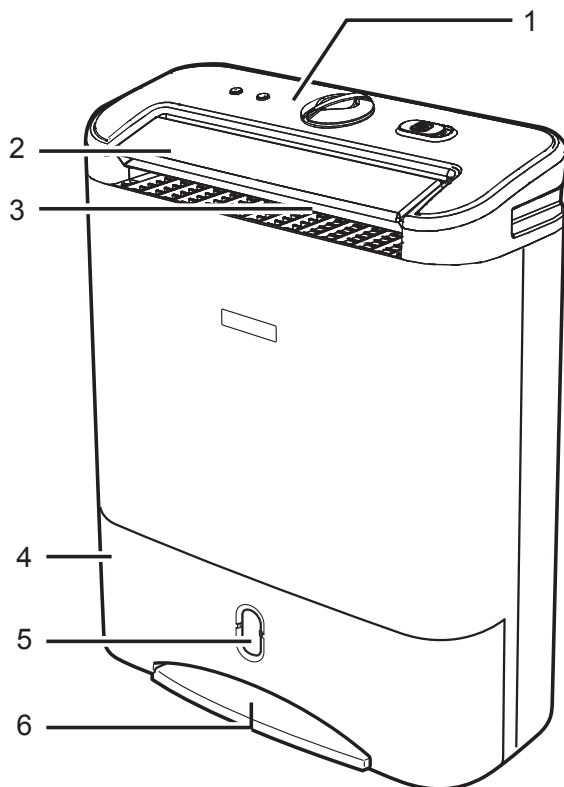

1. Control panel
2. Adjustable louvre
3. Air outlet
4. Bucket
5. Water level viewer
6. Hand grip to pull out the bucket

7. Air filter
8. Power cord tie hole
9. Cord tie
10. Power cord
11. Air inlet
12. Continuous drain hole

# THE CONTROL PANEL

## Water Full / Check indicator

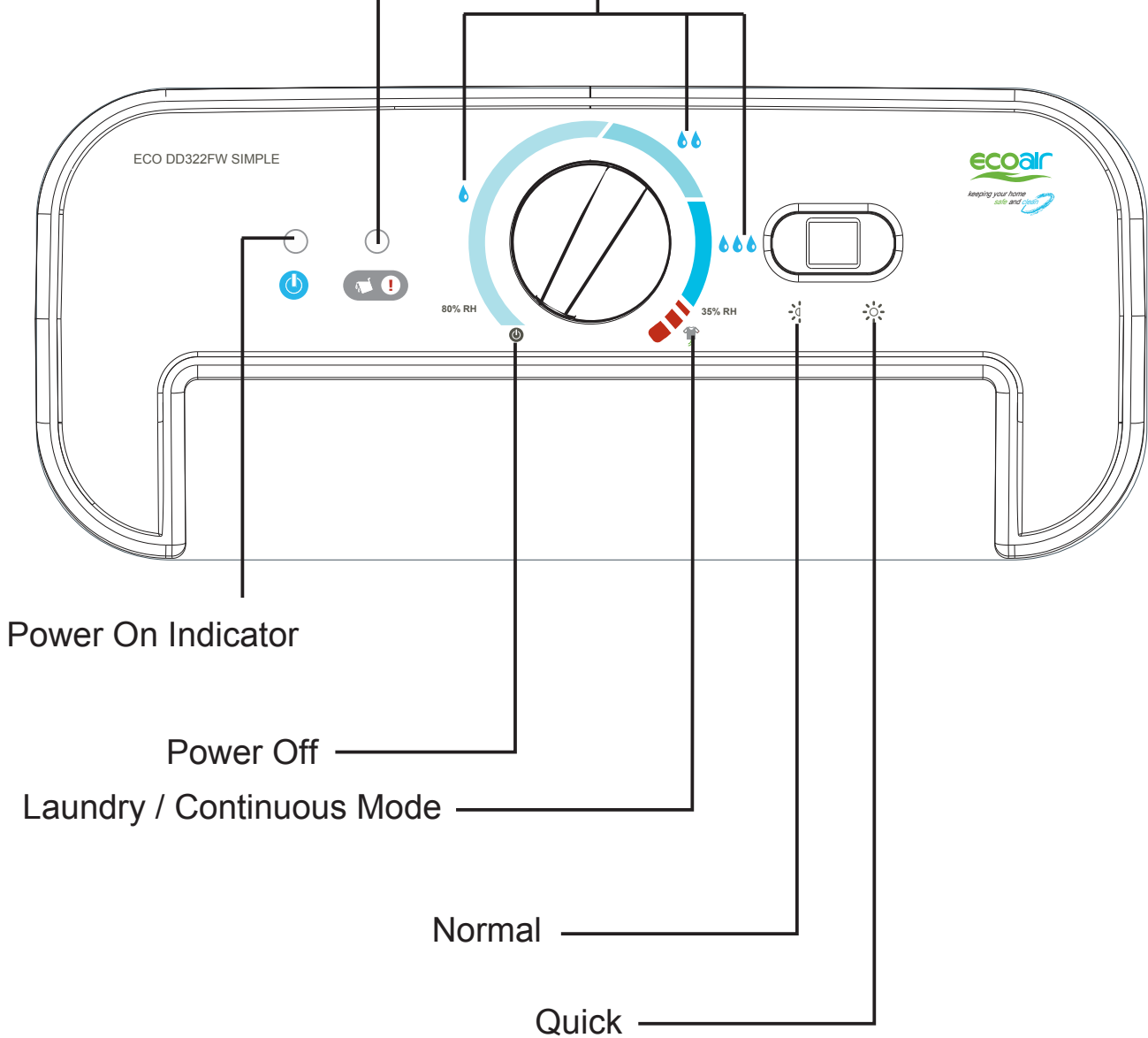

Indicator lights up when the bucket full of water or incorrectly installed or the unit malfunctions.

## Dry Mode Setting

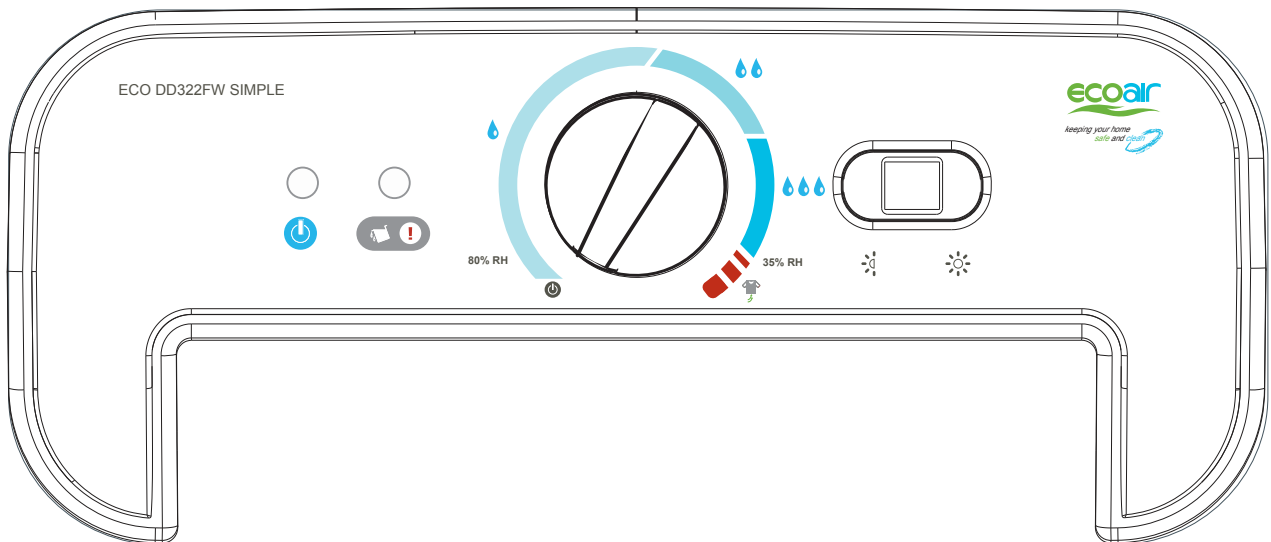





## Humidistat

Turn the knob clockwise to turn on the unit with a desired humidity setting. Turn it counterclockwise to switch off. The humidistat can be set along  (80~60%RH),  (60~45%RH),  (45~35%RH) or other positions to control the unit on and off automatically for keeping the room humidity at a suitable humidity. At Laundry, the unit will run continuously until the bucket is full.

## Power Selection Switch

Push the switch the button to the right for  (high heating power and high fan speed).

Push the switch the button to the left for  (low heating power and low fan speed).

## Indicating Lamps



Power On Indicator  : Lights up when the unit is turned on by the humidistat.

Full / Check Indicator  : Lights up when the bucket is full, or when the unit malfunctions, see troubleshooting on Page 10.

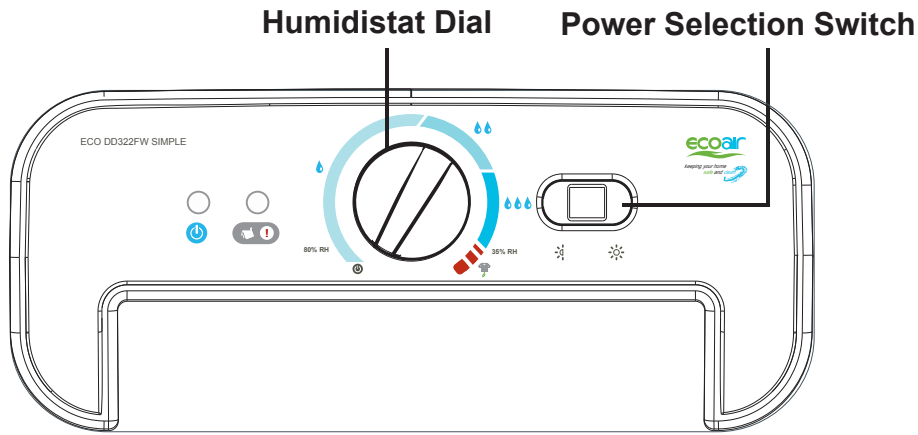
# HOW TO USE YOUR DEHUMIDIFIER



## Humidistat Dial

-  **Economy** – Dries the air to approximately (80-60%RH) and stops dehumidifying
-  **Medium** – Dries the air to approximately (60-45%RH) and stops dehumidifying.
-  **Hi** – Dries the air to approximately (45-35%RH) and stops dehumidifying.



## Laundry Mode

Use the Laundry mode to dry your clothes. It will continuously dry the air.

*Tip: It typically takes 2 – 8 hours to dry your laundry.*

**Avoid using the Laundry mode for normal daily use. You may use for extreme drying of very damp rooms over 2 - 3 days and then switch to the recommended**

**or  +  mode.**

## Power Selection Switch

### Normal

For energy saving, the unit will run at low fan speed and low heating to maintain your RH. We recommend this mode for normal use.

### Quick

This mode is for rapid dehumidifying as the unit will run on high fan speed and high heating to get your desired RH quickly.

*Tip: Once you reach your desired RH, switch from  to  for energy saving.*

RH = Relative Humidity

## Full / Check

 Lights up when:

1. Bucket is full or not properly inserted.
2. Filter needs cleaning.
3. Appliance needs to cool down. Switch off and leave for 30 minutes and turn on again. This is normal.
4. In low humidity or temperature conditions.
5. In high temperature condition over 35°C

*Tip: When the check light comes on, switch off the unit and let it cool down before switch it on again and only use when the moisture level increase in the same room or move it to another wet room. Make sure the dehumidifier is placed in a safe distance away from any obstacles. (See unit setup in the next page)*



# UNIT SETUP

- Place the unit in an upright position on a stable, level surface. (Please ensure unit is not sitting on its own cable).
- Please ensure the unit is a safe distance away from a wall or furniture (see the right graphic).
- Please keep clothes at a safe distance of 60 cm from air outlet of the unit to prevent water dripping into the unit.
- Where to position your dehumidifier?  
For best results position the dehumidifier somewhere central like a landing or a hallway.  
As long as the internal doors are open the excess moisture from all of the rooms in the house will migrate naturally towards the dehumidifier and be processed.

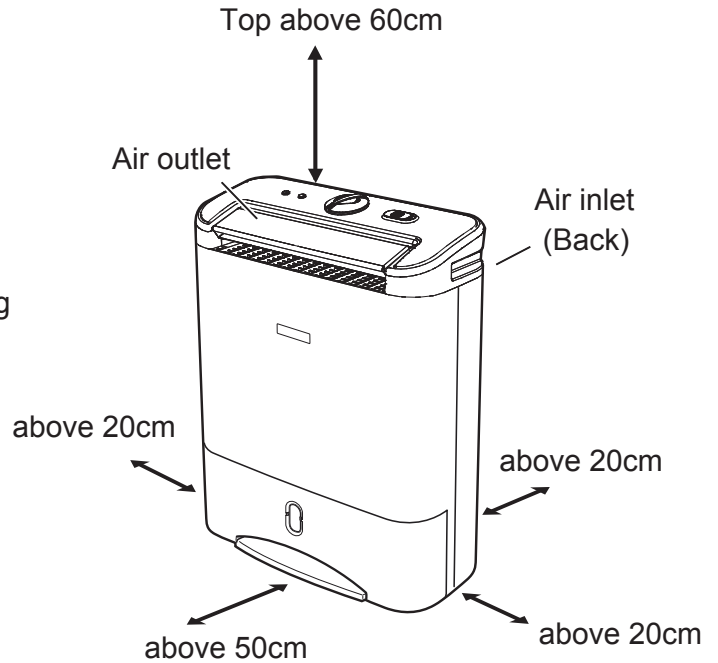

## Caution !

Do not place the dehumidifier in a broom cupboard, boiler room, small unventilated rooms etc.  
Avoid placing the dehumidifier in small confined areas or in close proximity to a radiator or heat source such as tumble driers, cookers etc. to avoid the dehumidifier from overheating.



Do not use this dehumidifier in dusty or an industrial environment where particles can get into the dehumidifier. This will cause a malfunction and void your warranty.

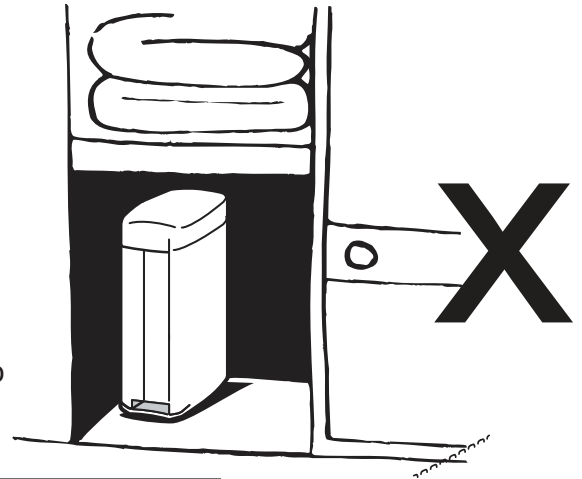

# TO OPERATE SAFELY

- Do not insert small objects into the unit or this will damage it and cause a hazard.
- Do not attempt to remove bucket while unit is in operation to avoid water leakage.
- Keep suitable space as above
- Ensure bucket is fitted correctly.

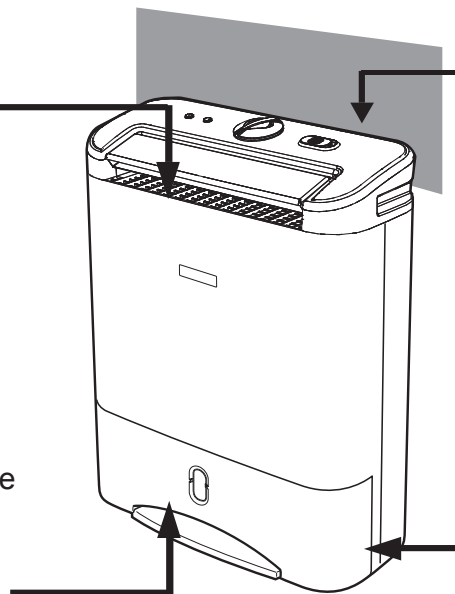

## TO EMPTY THE BUCKET

1. When the bucket is full, the Full/Check LED lights up and the unit stops.
2. Do not move the unit or remove the bucket, if the machine is still operating, as water may leak, damage the unit or cause an electric shock.
3. To remove the bucket, pull it out by gripping the bottom of the bucket, and lift carefully.
4. Remove the cover of bucket first, then pour the water away, clean the bucket and restore the cover and the bucket to the correct position.

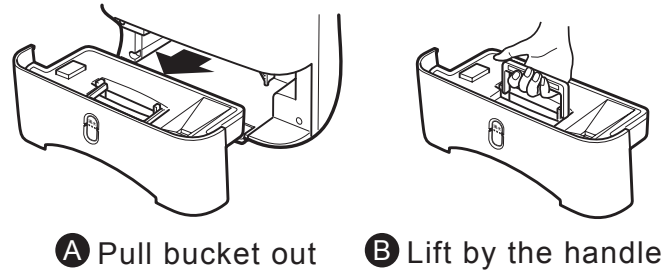

**A** Pull bucket out    **B** Lift by the handle

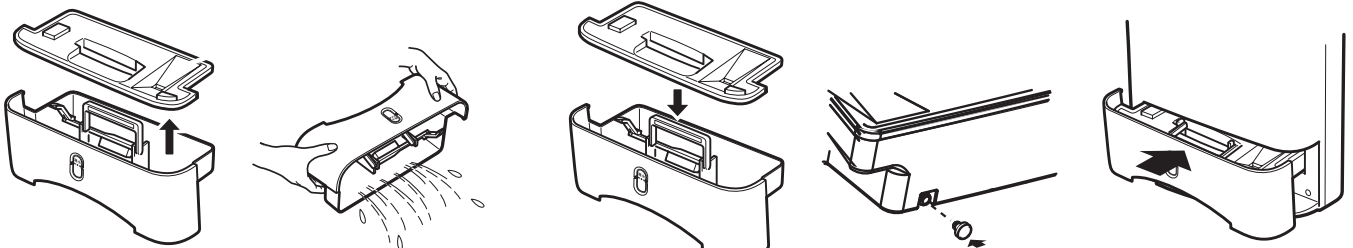

**C** Remove the cover    **D** Pour the water contents    **E** Refit the cover    **F** Check the rubber plug    **G** Restore the bucket is inside drain hole

### NOTE:

- Clean the bucket with clean water if needed. Do not use detergent, solvent, abrasive or hot water to avoid damage to the appliance.
- Do not remove or damage the float in the bucket, the unit will not work correctly.
- The bucket cover must be well fitted in position.
- The "Full/Check" LED lights if the bucket is not well in place.

## PERMANENT DRAIN OPTION

A hose with an inner diameter of 12mm can be connected for continuous drainage.

1. Remove the bucket.
2. There is a through hole at the lower left corner on the back of the appliance.
3. Pass the hose through the hole.
4. Remove the plug from the drain hole at the back of the bucket. **Keep it safely for future use.**
5. Push and connect the hose firmly to the drain hole of the bucket.
6. Restore the bucket in the correct position.

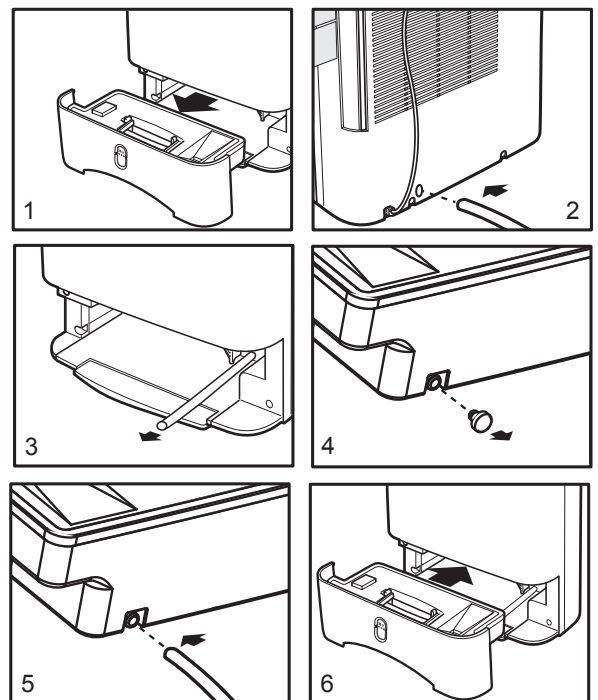

## Cleaning the filter

*Tip: Clean your filter every 2 weeks to keep your air clean and prolong the life of your dehumidifier.*

### How to Clean

1. Turn off the unit and remove the filter from the unit.
2. Remove the filter located at the back of the appliance.
3. Clean the filter using clean water and dry it before use, or alternatively clean using a vacuum cleaner.
4. Replace the filter in position.
5. Never run the unit without the filter.
6. If the filter is covered by dust, the airflow and performance of the unit will be affected. Check the filter periodically to ensure any dust is removed.

### Caution



Always ensure that fine particles or small objects do not enter the dehumidifier through the air outlet. Dust build-up in the unit can cause malfunction and overheating.

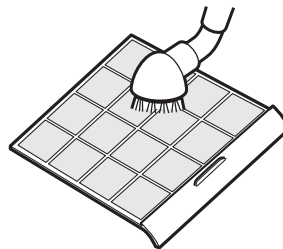
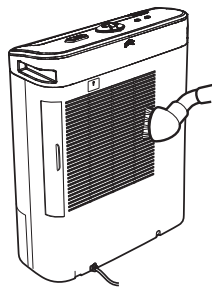

## Cleaning the unit

1. Turn the appliance OFF, ensure the plug is removed from the socket outlet.
2. Clean the casing using a soft damp cloth with warm water and mild detergent. Do not use solvents or abrasive materials.
3. Use a soft dry cloth to wipe the casing dry.
4. To avoid damage to internal parts, do not let water to drip into the air inlet or outlet and do not wash the machine with water.

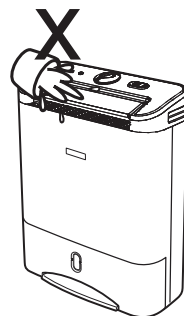

## Before storing

1. Turn off the unit, unplug from the power socket.
2. Clean and dry the bucket. Leave the unit to drain for approximately one day.
3. Clean the filter and the unit. Cover the unit to prevent it from gathering dust. Store upright in a cool dry place.
4. Do not expose to direct sunlight.

# TROUBLESHOOTING

The following conditions are normal:

1. The unit works within room temperature about 1~35°C. It may stop operation out of this range or when the air inlet or outlet is covered. (The "Full / Check" LED light will illuminate)
2. The unit includes heater function that could increase the room temperature. If your Dehumidifier stops working or "Full / Check" LED illuminates, please check the following items first.

Problem	Possible Causes	What to Do
Dehumidifier doesn't start (no lamp)	The unit is unplugged	<ul style="list-style-type: none"> <li>• Make sure the plug is pushed completely into the outlet.</li> </ul>
	The fuse is blown or circuit breaker is tripped	<ul style="list-style-type: none"> <li>• Check the house fuse / circuit breaker box and replace fuse or reset the breaker.</li> </ul>
	The room humidity has reached the setting	<ul style="list-style-type: none"> <li>• If you turn the humidistat clockwise the unit should turn on for a drier humidity level.</li> </ul>
Full / Check lamp lights	The bucket is full or not in place	<ul style="list-style-type: none"> <li>• Empty the bucket, check the float in position, and replace the bucket.</li> </ul>
	The unit is not level on the floor / surface	<ul style="list-style-type: none"> <li>• Place the unit on a stable, level surface.</li> </ul>
	The air inlet or outlet is covered / blocked	<ul style="list-style-type: none"> <li>• Make sure there is nothing blocking the air inlet and air outlet of the unit. Clean the filter. Unplug and wait at least 30 minutes to resume operation.</li> </ul>
	Filter clogged with dust	
	Lack of air ventilation in the room	<ul style="list-style-type: none"> <li>• Do not use it in a small and closed place where heat accumulates.</li> <li>• Move to a cooler place, wait at least 30 minutes to resume operation.</li> <li>• Unit has safety feature to prevent it from overheat, wait at least 30 minutes to resume operation.</li> </ul>
	The ambient temperature is too high, such as over 35°C	
Water on floor	The unit is not level	<ul style="list-style-type: none"> <li>• Check the unit is placed on a level surface and not accidentally sitting on a cable etc.</li> </ul>
	The drainage is clogged or loose	<ul style="list-style-type: none"> <li>• Check the drainage hose and its connection.</li> </ul>
	Rubber plug missing from the bucket	<ul style="list-style-type: none"> <li>• Fix the plug in the bucket</li> </ul>

## NOTE:

1. If the "Full / Check" LED illuminates, turn off the unit, unplug from the power socket, check and clean the filter. If it is dirty, remove any obstacle that covers the air inlet or outlet, and wait for at least ten minutes before plugging in and switching back on.
2. Under low temperature and low humidity conditions, "Full / Check" may come on to prevent unit from overheating. Move unit to a warmer and damper room and wait 30 minutes before switching on.

**Do not try to repair it by yourself, as this could cause an electrical shock and void your warranty.**

## Smell coming from the dehumidifier

When you first use the dehumidifier and periodically afterwards you might notice a smell coming from the dehumidifier. This is caused by the Zeolite desiccant material and is not a sign that the dehumidifier is faulty, nor is it harmful to humans or pets. The smell occurs because the Zeolite absorbs odours from items like cigarettes, cosmetics, hair sprays, building materials and new furniture and then when the desiccant is heated the smell is discharged into the room. This smell has been described as being like a burning smell or a sour smell. It is normal, will not last long and is not a sign of a fault.

## Amount of water collected

When you first use your dehumidifier it will work harder to reduce the room humidity to its target of eg. 55-60%RH (on Auto mode), this is the time when it will produce the most water and need emptying most frequently. As the room becomes dryer the dehumidifier collects less water and runs at a lower fan speed. This is normal. When the target relative humidity has been reached the air coming out of the dehumidifier will not be heated and it will only be running in low fan mode. This is because there is no need for dehumidification at this point and the dehumidifier is sampling the air to check the current relative humidity to see if dehumidification is required.

If you find that you still have condensation on your windows or you need to dry the air further then using the High fan speed, or the Turbo Laundry mode, will force the dehumidifier to dry the air further to 40-45%RH. This might well be necessary if you have single glazed windows or if the outside air temperature drops to freezing.

## Ventilation

The dehumidifier must not be placed in a confined space. Move the dehumidifier to a well ventilated area for example in a hallway, landing or a ventilated room. Ensure that its not in close proximity to any form of heat source, such as a radiator or appliances that generate heat (eg tumble dryer or cooker). The air inlet and outlet must not be obstructed.

# SPECIFICATIONS

Model: ECO DD322FW SIMPLE

Operating Temperature Range: 1°C - 35°C

Dehumidifier extraction Rate: 10 Litres/Day(20°C, 60%RH)

Bucket Capacity: 3.5 Litres

Power: High: 620-720W / Low:400-460W

Voltage: 220-240V ~ /50Hz

Net Weight: 8.5Kg

Dimensions: Width 416 x Depth 186 x Height 552 (mm)

## ONE (1) YEAR LIMITED WARRANTY

### Save This Warranty Information

**Eco Air** guarantees this product free from defects in materials and workmanship for a period of one (1) year from the date of purchase. Coverage is valid only with proof of purchase.

This unit must be operated under conditions as recommended, at voltage indicated on the unit. Any attempts made to service or modify the unit, will render this WARRANTY VOID. The actual product may differ slightly from illustration. This warranty is in addition to, and does not affect, your statutory rights.

For further information, please contact 020 8459 2458.

This product has been manufactured to comply with the EC Directives 2006/95/EC and 2004/108/EC.

We recommend that you note the details of your purchase below and retain your original proof of purchase receipt with this manual. Keep these documents safe in the event of a warranty claim.

Date of purchase: \_\_\_\_\_  
Retailer name: \_\_\_\_\_  
Serial number: \_\_\_\_\_



*keeping your home  
safe and clean*



Copyright Reserved